

1

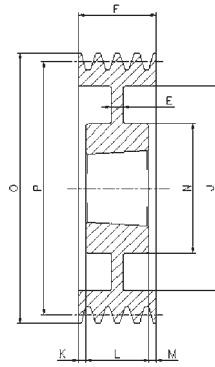

6

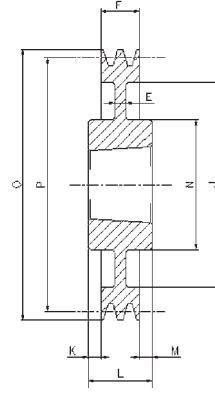

7

# SPB/1

Cod. interno Internal code Intern Code Code interne Código interno	Tipo Type Typ Type Tipo	Gole Grooves Rillen Gorges Canales	P	O	Forma Form Forme Forme Forma	Bussola Bush Buchse Moyeu Casquillo	Ø MAX	E	F	J	K	L	M	N
BT01001	SPB100-01	1	100	107	1	1610	42	-	25	-	-	25	-	-
BT01061	SPB106-1	1	106	113	1	1610	42	-	25	-	-	25	-	-
BT01121	SPB112-01	1	112	119	1	1610	42	-	25	-	-	25	-	-
BT01181	SPB118-01	1	118	125	1	1610	42	-	25	-	-	25	-	-
BT01251	SPB125-01	1	125	132	1	1610	42	-	25	-	-	25	-	-
BT01321	SPB132-01	1	132	139	1	1610	42	-	25	-	-	25	-	-
BT01401	SPB140-01	1	140	147	1	1610	42	-	25	-	-	25	-	-
BT01501	SPB150-01	1	150	157	1	1610	42	-	25	-	-	25	-	-
BT01601	SPB160-01	1	160	167	1	1610	42	-	25	-	-	25	-	-
BT01701	SPB170-01	1	170	177	1	1610	42	-	25	-	-	25	-	-
BT01801	SPB180-01	1	180	187	6	1610	42	15	25	132	-	25	-	90
BT01901	SPB190-01	1	190	197	7	2012	50	15	25	147	3,5	32	3,5	104
BT02001	SPB200-01	1	200	207	7	2012	50	15	25	157	3,5	32	3,5	104
BT02121	SPB212-01	1	212	219	7	2012	50	15	25	169	3,5	32	3,5	104
BT02241	SPB224-01	1	224	231	7	2012	50	15	25	181	3,5	32	3,5	104
BT02361	SPB236-01	1	236	243	7	2012	50	15	25	193	3,5	32	3,5	104
BT02501	SPB250-01	1	250	257	7	2012	50	20	25	207	3,5	32	3,5	104
BT02801	SPB280-01	1	280	287	7	2012	50	20	25	237	3,5	32	3,5	104
BT03001	SPB300-01	1	300	307	7	2012	50	20	25	258	3,5	32	3,5	104
BT03151	SPB315-01	1	315	322	7	2012	50	20	25	272	3,5	32	3,5	104

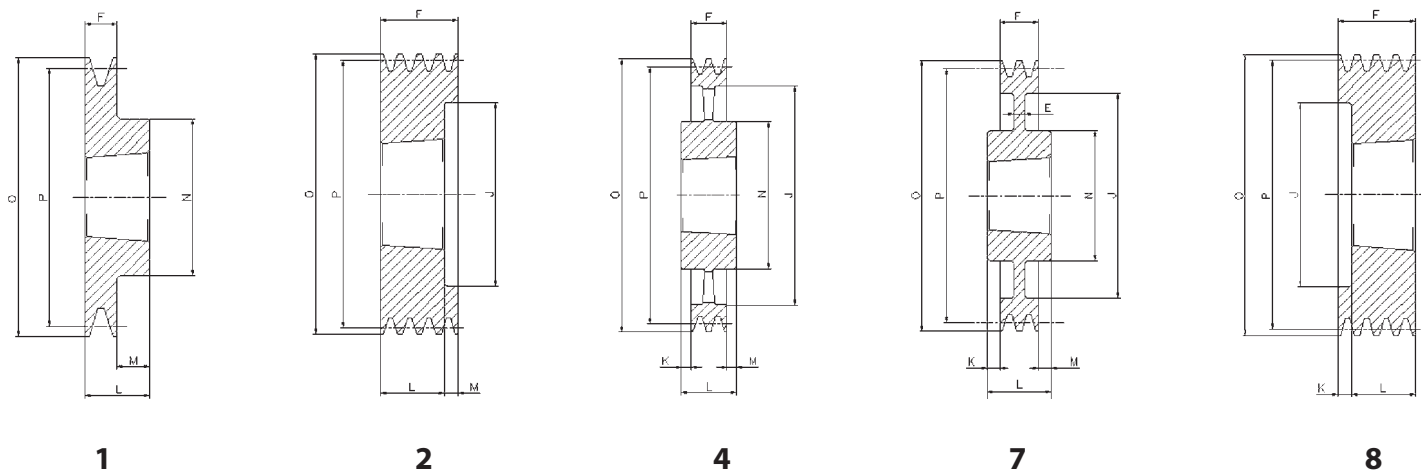

# SPB/2

Cod. interno Internal code Intern Code Code interne Código interno	Tipo Type Typ Type Tipo	Gole Grooves Rillen Gorges Canales	P	O	Forma Form Forme Forme Forma	Bussola Bush Buchse Moyeu Casquillo	Ø MAX	E	F	J	K	L	M	N
BT01002	SPB100-02	2	<b>100</b>	107	8	1610	42	-	44	62	19,0	25	-	-
BT01062	SPB106-02	2	<b>106</b>	113	8	1610	42	-	44	67	19,0	25	-	-
BT01122	SPB112-02	2	<b>112</b>	119	8	1610	42	-	44	72	19,0	25	-	-
BT01182	SPB118-02	2	<b>118</b>	125	2	1610	42	-	44	78	-	25	19,0	-
BT01252	SPB125-02	2	<b>125</b>	132	2	2012	50	-	44	82	-	32	12,0	-
BT01322	SPB132-02	2	<b>132</b>	139	2	2012	50	-	44	89	-	32	12,0	-
BT01402	SPB140-02	2	<b>140</b>	147	2	2012	50	-	44	97	-	32	12,0	-
BT01502	SPB150-02	2	<b>150</b>	157	2	2012	50	-	44	107	-	32	12,0	-
BT01602	SPB160-02	2	<b>160</b>	167	2	2012	50	-	44	117	-	32	12,0	-
BT01702	SPB170-02	2	<b>170</b>	177	2	2012	50	-	44	127	-	32	12,0	-
BT01802	SPB180-02	2	<b>180</b>	187	1	2517	60	-	44	-	-	45	1,0	120
BT01902	SPB190-02	2	<b>190</b>	197	1	2517	60	-	44	-	-	45	1,0	120
BT02002	SPB200-02	2	<b>200</b>	207	1	2517	60	-	44	-	-	45	1,0	117
BT02122	SPB212-02	2	<b>212</b>	219	7	2517	60	20	44	169	-	45	1,0	117
BT02242	SPB224-02	2	<b>224</b>	231	7	2517	60	15	44	181	-	45	1,0	117
BT02362	SPB236-02	2	<b>236</b>	243	7	2517	60	15	44	193	-	45	1,0	117
BT02502	SPB250-02	2	<b>250</b>	257	7	2517	60	20	44	207	-	45	1,0	125
BT02802	SPB280-02	2	<b>280</b>	287	7	2517	60	20	44	237	-	45	1,0	125
BT03002	SPB300-02	2	<b>300</b>	307	7	2517	60	20	44	257	-	45	1,0	125
BT03152	SPB315-02	2	<b>315</b>	322	7	2517	60	20	44	272	-	45	1,0	125
BT03352	SPB335-02	2	<b>335</b>	342	7	2517	60	20	44	292	-	45	1,0	125
BT03552	SPB355-02	2	<b>355</b>	362	7	3020	75	15	44	312	3,5	51	3,5	144
BT04002	SPB400-02	2	<b>400</b>	407	4	3020	75	-	44	357	3,5	51	3,5	150
BT04502	SPB450-02	2	<b>450</b>	457	4	3020	75	-	44	407	3,5	51	3,5	150
BT05002	SPB500-02	2	<b>500</b>	507	4	3020	75	-	44	457	3,5	51	3,5	150
BT05602	SPB560-02	2	<b>560</b>	567	4	3030	75	-	44	517	4,0	76	28,0	150
BT06302	SPB630-02	2	<b>630</b>	637	4	3030	75	-	44	587	16,0	76	16,0	150

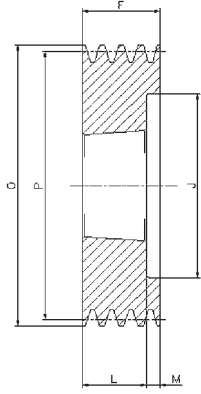

2

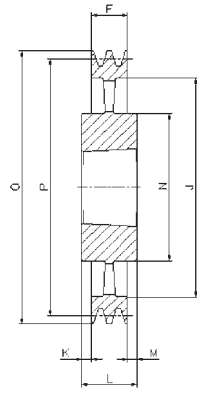

4

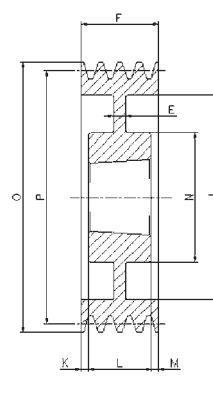

6

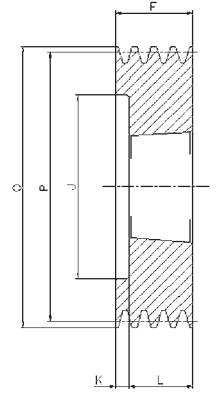

8

# SPB/3

Cod. interno Internal code Intern Code Code interne Código interno	Tipo Type Typ Type Tipo	Gole Grooves Rillen Gorges Canales	P	O	Forma Form Forme Forme Forma	Bussola Bush Buchse Moyeu Casquillo	Ø MAX	E	F	J	K	L	M	N
BT01003	SPB100-03	3	100	107	8	1610	42	-	63	62	38,0	25	-	-
BT01063	SPB106-03	3	106	113	8	1610	42	-	63	67	38,0	25	-	-
BT01123	SPB112-03	3	112	119	8	1610	42	-	63	72	38,0	25	-	-
BT01183	SPB118-03	3	118	125	2	1610	42	-	63	78	-	25	38,0	-
BT01253	SPB125-03	3	125	132	2	2012	50	-	63	82	-	32	31,0	-
BT01323	SPB132-03	3	132	139	2	2012	50	-	63	89	-	32	31,0	-
BT01403	SPB140-03	3	140	147	2	2012	50	-	63	97	-	32	31,0	-
BT01503	SPB150-03	3	150	157	2	2517	60	-	63	107	-	45	18,0	-
BT01603	SPB160-03	3	160	167	2	2517	60	-	63	117	-	45	18,0	-
BT01703	SPB170-03	3	170	177	2	2517	60	-	63	127	-	45	18,0	-
BT01803	SPB180-03	3	180	187	2	2517	60	-	63	137	-	45	18,0	-
BT01903	SPB190-03	3	190	197	2	2517	60	-	63	147	-	45	18,0	-
BT02003	SPB200-03	3	200	207	2	2517	60	-	63	157	-	45	18,0	-
BT02123	SPB212-03	3	212	219	6	2517	60	15	63	169	-	45	18,0	117
BT02243	SPB224-03	3	224	231	6	2517	60	15	63	181	-	45	18,0	117
BT02363	SPB236-03	3	236	243	6	2517	60	15	63	193	-	45	18,0	117
BT02503	SPB250-03	3	250	257	6	3020	75	20	63	207	-	51	12,0	144
BT02803	SPB280-03	3	280	287	6	3020	75	20	63	237	6,0	51	6,0	144
BT03003	SPB300-03	3	300	307	6	3020	75	20	63	257	6,0	51	6,0	144
BT03153	SPB315-03	3	315	322	6	3020	75	20	63	272	6,0	51	6,0	144
BT03353	SPB335-03	3	335	342	6	3020	75	20	63	292	6,0	51	6,0	144
BT03553	SPB355-03	3	355	362	6	3020	75	15	63	312	6,0	51	6,0	144
BT04003	SPB400-03	3	400	407	4	3535	90	-	63	357	13,0	89	13,0	175
BT04503	SPB450-03	3	450	457	4	3535	90	-	63	407	-	89	26,0	175
BT05003	SPB500-03	3	500	507	4	3535	90	-	63	457	-	89	26,0	175
BT05603	SPB560-03	3	560	567	4	3535	90	-	63	517	-	89	26,0	175
BT06303	SPB630-03	3	630	637	4	3535	90	-	63	587	-	89	26,0	175
BT07103	SPB710-03	3	710	717	4	3535	90	-	63	664	13,0	89	13,0	175
BT08003	SPB800-03	3	800	807	4	3535	90	-	63	754	13,0	89	13,0	175
BT09003	SPB900-03	3	900	907	4	3535	90	-	63	854	13,0	89	13,0	175
BT10003	SPB1000-03	3	1000	1007	4	4040	100	-	63	954	19,5	102	19,5	210
BT12503	SPB1250-03	3	1250	1257	4	4040	100	-	63	1204	19,5	102	19,5	210

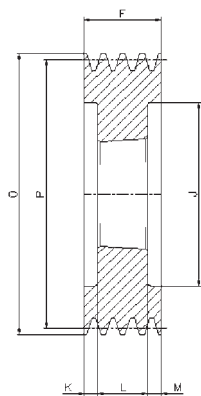

3

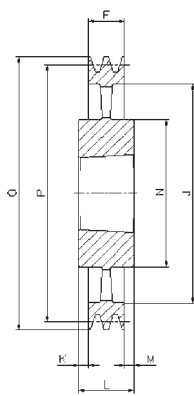

4

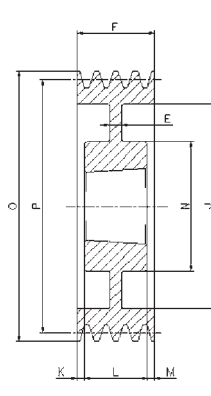

6

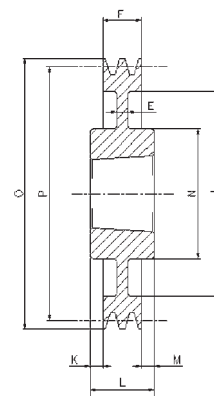

7

# SPB/4

Cod. interno Internal code Intern Code Code interne Código interno	Tipo Type Typ Type Tipo	Gole Grooves Rillen Gorges Canales	P	O	Forma Form Forme Forme Forma	Bussola Bush Buchse Moyeu Casquillo	Ø MAX	E	F	J	K	L	M	N
BT01004	SPB100-04	4	100	117	8	1615	42	-	82	60	44,0	38	-	-
BT01124	SPB112-04	4	112	119	8	2012	42	-	82	72	50,0	32	-	-
BT01184	SPB118-04	4	118	125	8	1610	42	-	82	75	57,0	25	-	-
BT01254	SPB125-04	4	125	132	3	2012	50	-	82	82	25,0	32	25,0	-
BT01324	SPB132-04	4	132	139	3	2012	50	-	82	89	25,0	32	25,0	-
BT01404	SPB140-04	4	140	147	3	2517	60	-	82	100	18,5	45	18,5	-
BT01504	SPB150-04	4	150	157	3	2517	60	-	82	107	18,5	45	18,5	-
BT01604	SPB160-04	4	160	167	3	2517	60	-	82	117	18,5	45	18,5	-
BT01704	SPB170-04	4	170	177	3	2517	60	-	82	127	18,5	45	18,5	-
BT01804	SPB180-04	4	180	187	3	2517	60	-	82	137	18,5	45	18,5	-
BT01904	SPB190-04	4	190	197	3	2517	60	-	82	147	18,5	45	18,5	-
BT02004	SPB200-04	4	200	207	3	3020	75	-	82	157	15,5	51	15,5	-
BT02124	SPB212-04	4	212	219	3	3020	75	-	82	169	15,5	51	15,5	-
BT02244	SPB224-04	4	224	231	3	3020	75	-	82	181	15,5	51	15,5	-
BT02364	SPB236-04	4	236	243	3	3020	75	-	82	193	15,5	51	15,5	-
BT02504	SPB250-04	4	250	257	6	3020	75	25	82	207	15,5	51	15,5	144
BT02804	SPB280-04	4	280	287	6	3020	75	25	82	237	15,5	51	15,5	144
BT03004	SPB300-04	4	300	307	7	3535	90	25	82	257	-	89	7,0	175
BT03154	SPB315-04	4	315	322	7	3535	90	25	82	272	3,5	89	3,5	175
BT03354	SPB335-04	4	335	342	7	3535	90	25	82	292	3,5	89	3,5	175
BT03554	SPB355-04	4	355	362	7	3535	90	25	82	312	3,5	89	3,5	175
BT04004	SPB400-04	4	400	407	4	3535	90	-	82	357	3,5	89	3,5	175
BT04504	SPB450-04	4	450	457	4	3535	90	-	82	407	-	89	7,0	175
BT05004	SPB500-04	4	500	507	4	3535	90	-	82	457	-	89	7,0	175
BT05604	SPB560-04	4	560	567	4	3535	90	-	82	517	-	89	7,0	175
BT06304	SPB630-04	4	630	637	4	3535	90	-	82	587	-	89	7,0	175
BT07104	SPB710-04	4	710	717	4	3535	90	-	82	664	3,5	89	3,5	175
BT08004	SPB800-04	4	800	807	4	4040	100	-	82	754	10,0	102	10,0	210
BT09004	SPB900-04	4	900	907	4	4040	100	-	82	854	10,0	102	10,0	210
BT10004	SPB1000-04	4	1000	1007	4	4040	100	-	82	954	10,0	102	16,0	210
BT12504	SPB1250-04	4	1250	1257	4	4545	110	-	82	1204	16,0	114	16,0	210

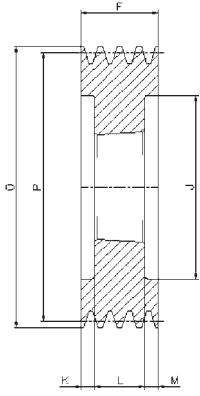

3

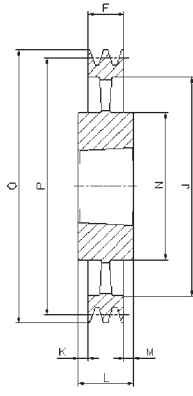

4

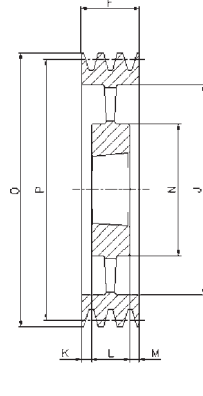

5

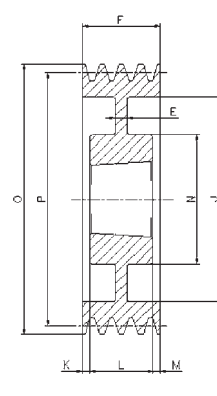

6

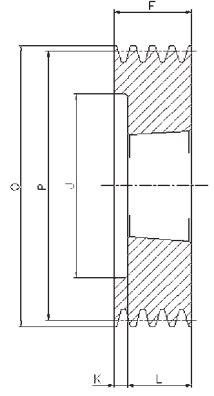

8

# SPB/5

Cod. interno Internal code Interne Code Code interne Código interno	Tipo Type Typ Type Tipo	Gole Grooves Rillen Gorges Canales	P	O	Forma Form Forme Forme Forma	Bussola Bush Buchse Moyeu Casquillo	∅ MAX	E	F	J	K	L	M	N
BT01255	SPB125-05	5	125	132	8	2012	50	-	101	87	69,0	32	-	-
BT01325	SPB132-05	5	132	139	8	2517	60	-	101	94	56,0	45	-	-
BT01405	SPB140-05	5	140	147	3	2517	60	-	101	97	28,0	45	28,0	-
BT01505	SPB150-05	5	150	157	3	2517	60	-	101	107	28,0	45	28,0	-
BT01605	SPB160-05	5	160	167	3	2517	60	-	101	117	28,0	45	28,0	-
BT01705	SPB170-05	5	170	177	3	3020	75	-	101	127	25,0	51	25,0	-
BT01805	SPB180-05	5	180	187	3	3020	75	-	101	137	25,0	51	25,0	-
BT01905	SPB190-05	5	190	197	3	3020	75	-	101	147	25,0	51	25,0	-
BT02005	SPB200-05	5	200	207	3	3020	75	-	101	157	25,0	51	25,0	-
BT02125	SPB212-05	5	212	219	3	3020	75	-	101	169	25,0	51	25,0	-
BT02245	SPB224-05	5	224	231	3	3020	75	-	101	181	25,0	51	25,0	-
BT02365	SPB236-05	5	236	243	3	3535	90	-	101	193	6,0	89	6,0	-
BT02505	SPB250-05	5	250	257	3	3535	90	-	101	207	6,0	89	6,0	-
BT02805	SPB280-05	5	280	287	6	3535	90	25	101	237	6,0	89	6,0	175
BT03005	SPB300-05	5	300	307	6	3535	90	25	101	257	6,0	89	6,0	175
BT03155	SPB315-05	5	315	322	6	3535	90	25	101	272	6,0	89	6,0	175
BT03355	SPB335-05	5	335	342	6	3535	90	25	101	292	6,0	89	6,0	175
BT03555	SPB355-05	5	355	362	6	3535	90	17	101	312	6,0	89	6,0	175
BT04005	SPB400-05	5	400	407	5	3535	90	-	101	357	6,0	89	6,0	175
BT04505	SPB450-05	5	450	457	5	3535	90	-	101	407	-	89	12,0	175
BT05005	SPB500-05	5	500	507	5	3535	90	-	101	457	-	89	12,0	175
BT05605	SPB560-05	5	560	567	4	4040	100	-	101	517	-	102	1,0	210
BT06305	SPB630-05	5	630	637	4	4040	100	-	101	587	-	102	1,0	210
BT07105	SPB710-05	5	710	717	4	4040	100	-	101	664	-	102	1,0	210
BT08005	SPB800-05	5	800	807	4	4040	100	-	101	754	-	102	1,0	210
BT09005	SPB900-05	5	900	907	4	4040	100	-	101	854	-	102	1,0	210
BT10005	SPB1000-05	5	1000	1007	4	4545	110	-	101	954	6,5	114	6,5	242
BT12505	SPB1250-05	5	1250	1257	4	4545	110	-	101	1204	6,5	114	6,5	242

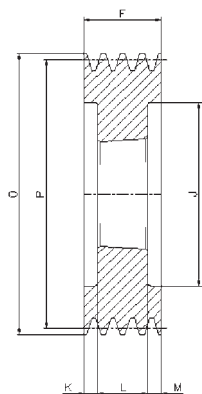

3

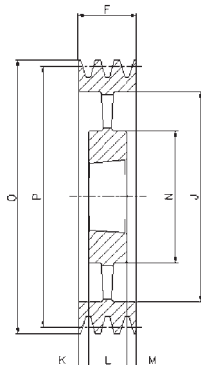

5

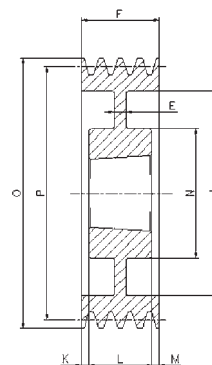

6

# SPB/6

Cod. interno Internal code Intern Code Code interne Código interno	Tipo Type Typ Type Tipo	Gole Grooves Rillen Gorges Canales	P	O	Forma Forme Forme Forme Forma	Bussola Buchse Moyeu Casquillo	Ø MAX	E	F	J	K	L	M	N
BT01406	SPB140-06	6	140	147	3	2517	60	-	120	100	37,5	45	37,5	-
BT01506	SPB150-06	6	150	157	3	2517	60	-	120	107	37,5	45	37,5	-
BT01606	SPB160-06	6	160	167	3	3020	75	-	120	117	34,5	51	34,5	-
BT01706	SPB170-06	6	170	177	3	3020	75	-	120	127	34,5	51	34,5	-
BT01806	SPB180-06	6	180	187	3	3020	75	-	120	137	34,5	51	34,5	-
BT01906	SPB190-06	6	190	197	3	3020	75	-	120	147	34,5	51	34,5	-
BT02006	SPB200-06	6	200	207	3	3020	75	-	120	157	34,5	51	34,5	-
BT02126	SPB212-06	6	212	219	3	3535	90	-	120	169	15,5	89	15,5	-
BT02246	SPB224-06	6	224	231	3	3535	90	-	120	181	15,5	89	15,5	-
BT02366	SPB236-06	6	236	243	3	3535	90	-	120	193	15,5	89	15,5	-
BT02506	SPB250-06	6	250	257	3	3535	90	-	120	207	15,5	89	15,5	-
BT02806	SPB280-06	6	280	287	6	3535	90	25	120	237	15,5	89	15,5	175
BT03006	SPB300-06	6	300	307	6	3535	90	25	120	257	15,5	89	15,5	175
BT03156	SPB315-06	6	315	322	6	3535	90	25	120	272	15,5	89	15,5	175
BT03356	SPB335-06	6	335	342	6	3535	90	25	120	292	15,5	89	15,5	175
BT03556	SPB355-06	6	355	362	6	3535	90	25	120	312	15,5	89	15,5	175
BT04006	SPB400-06	6	400	407	5	3535	90	-	120	357	15,5	89	15,5	175
BT04506	SPB450-06	6	450	457	5	4040	100	-	120	407	-	102	18,0	210
BT05006	SPB500-06	6	500	507	5	4040	100	-	120	457	-	102	18,0	210
BT05606	SPB560-06	6	560	567	5	4040	100	-	120	517	-	102	18,0	210
BT06306	SPB630-06	6	630	637	5	4040	100	-	120	587	-	102	18,0	210
BT07106	SPB710-06	6	710	717	5	4040	100	-	120	664	9,0	102	9,0	210
BT08006	SPB800-06	6	800	807	5	4545	110	-	120	754	3,0	114	3,0	242
BT09006	SPB900-06	6	900	907	5	4545	110	-	120	854	3,0	114	3,0	242
BT10006	SPB1000-06	6	1000	1007	5	4545	110	-	120	954	3,0	114	3,0	242
BT12506	SPB1250-06	6	1250	1257	5	4545	110	-	120	1204	3,0	114	3,0	242

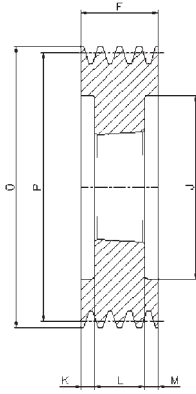

3

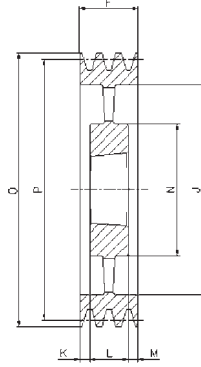

5

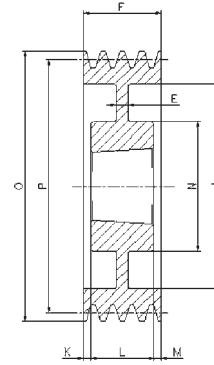

6

# SPB/8

Cod. interno Internal code Internar Code Code interne Código interno	Tipo Type Typ Type Tipo	Gole Grooves Rillen Gorges Canales	P	O	Forma Form Forme Forme Forma	Bussola Bush Buchse Moyeu Casquillo	Ø MAX	E	F	J	K	L	M	N
BT01408	SPB140-08	8	140	147	3	2517	60	-	158	97	56,5	45	56,5	-
BT01608	SPB160-08	8	160	167	3	3020	75	-	158	117	53,5	51	53,5	-
BT01708	SPB170-08	8	170	177	3	3030	75	-	158	127	41,0	76	41,0	-
BT01808	SPB180-08	8	180	187	3	3030	75	-	158	137	41,0	76	41,0	-
BT01908	SPB190-08	8	190	197	3	3030	75	-	158	147	41,0	76	41,0	-
BT02008	SPB200-08	8	200	207	3	3535	90	-	158	157	34,5	89	34,5	-
BT02128	SPB212-08	8	212	219	3	3535	90	-	158	169	34,5	89	34,5	-
BT02248	SPB224-08	8	224	231	3	3535	90	-	158	181	34,5	89	34,5	-
BT02368	SPB236-08	8	236	243	3	3535	90	-	158	193	34,5	89	34,5	-
BT02508	SPB250-08	8	250	257	3	3535	90	-	158	207	34,5	89	34,5	-
BT02808	SPB280-08	8	280	287	6	3535	90	25	158	237	34,5	89	34,5	175
BT03008	SPB300-08	8	300	307	6	3535	90	25	158	257	34,5	89	34,5	175
BT03158	SPB315-08	8	315	322	6	3535	90	25	158	272	34,5	89	34,5	175
BT03358	SPB335-08	8	335	342	6	3535	90	25	158	292	34,5	89	34,5	175
BT03558	SPB355-08	8	355	362	6	3535	90	25	158	312	34,5	89	34,5	175
BT04008	SPB400-08	8	400	407	6	4040	100	30	158	357	28,0	102	28,0	210
BT04508	SPB450-08	8	450	457	5	4040	100	-	158	407	28,0	102	28,0	210
BT05008	SPB500-08	8	500	507	5	4040	100	-	158	457	28,0	102	28,0	210
BT05608	SPB560-08	8	560	567	5	4545	110	-	158	517	22,0	114	22,0	242
BT06308	SPB630-08	8	630	637	5	4545	110	-	158	587	22,0	114	22,0	242
BT07108	SPB710-08	8	710	717	5	4545	110	-	158	664	22,0	114	22,0	242
BT08008	SPB800-08	8	800	807	5	4545	110	-	158	754	22,0	114	22,0	242
BT09008	SPB900-08	8	900	907	5	4545	110	-	158	854	22,0	114	22,0	242
BT10008	SPB1000-08	8	1000	1007	5	5050	125	-	158	954	15,5	127	15,5	267
BT12508	SPB1250-08	8	1250	1257	5	5050	125	-	158	1204	15,5	127	15,5	267

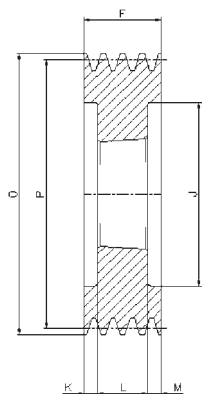

3

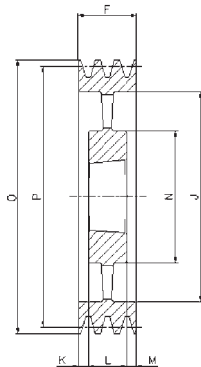

5

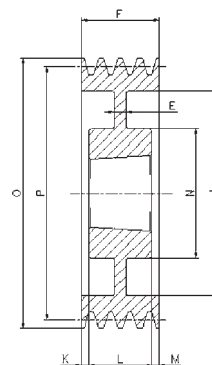

6

# SPB/10

Cod. interno Internal code Intern Code Code interne Código interno	Tipo Type Typ Type Tipo	Gole Grooves Rillen Gorges Canales	P	O	Forma Form Forme Forme Forma	Bussola Bush Buchse Moyeu Casquillo	∅ MAX	E	F	J	K	L	M	N
BT0200X	SPB200-10	10	<b>200</b>	207	3	3535	90	-	196	157	53,5	89	53,5	-
BT0224X	SPB224-10	10	<b>224</b>	231	3	3535	90	-	196	181	53,5	89	53,5	-
BT0236X	SPB236-10	10	<b>236</b>	243	3	3535	90	-	196	193	53,5	89	53,5	-
BT0250X	SPB250-10	10	<b>250</b>	257	3	3535	90	-	196	207	53,5	89	53,5	-
BT0280X	SPB280-10	10	<b>280</b>	287	6	3535	90	30	196	237	53,5	89	53,5	175
BT0315X	SPB315-10	10	<b>315</b>	322	6	3535	90	30	196	272	53,5	89	53,5	175
BT0335X	SPB335-10	10	<b>335</b>	342	6	4040	100	30	196	292	47,0	102	47,0	210
BT0355X	SPB355-10	10	<b>355</b>	362	6	4040	100	30	196	312	47,0	102	47,0	210
BT0400X	SPB400-10	10	<b>400</b>	407	6	4040	100	30	196	357	47,0	102	47,0	210
BT0450X	SPB450-10	10	<b>450</b>	457	5	4545	110	-	196	407	41,0	114	41,0	242
BT0500X	SPB500-10	10	<b>500</b>	507	5	4545	110	-	196	457	41,0	114	41,0	242
BT0560X	SPB560-10	10	<b>560</b>	567	5	4545	110	-	196	517	41,0	114	41,0	242
BT0630X	SPB630-10	10	<b>630</b>	637	5	4545	110	-	196	587	41,0	114	41,0	242
BT0710X	SPB710-10	10	<b>710</b>	717	5	4545	110	-	196	664	41,0	114	41,0	242
BT0800X	SPB800-10	10	<b>800</b>	807	5	4545	110	-	196	754	41,0	114	41,0	242
BT0900X	SPB900-10	10	<b>900</b>	907	5	5050	125	-	196	854	34,5	127	34,5	267
BT1000X	SPB1000-10	10	<b>1000</b>	1007	5	5050	125	-	196	954	34,5	127	34,5	267